

www.falconmedical.pl

D₁₈

Veterinary instruments for small animals / Instrumenty weterynaryjne dla małych zwierząt



Falcon[®]
Medical Polska
Your Instruments since 1975





Mouth gags for cats and dogs / Rozwieraki dla kotów i psów



Grays
For cats / Dla kotów

DV.003.030	30 mm
DV.003.055	55 mm
DV.003.075	75 mm



Grays
For dogs / Dla psów

DV.007.115	115 mm
DV.007.145	145 mm
DV.007.180	180 mm



Smith-Baxter
For dogs / Dla psów

DV.010.055	55 mm
DV.010.065	65 mm
DV.010.100	100 mm
DV.010.140	140 mm
DV.010.150	150 mm

Lip retractor for dogs / Rozwierak do warg dla psa



DV.015.165
165 mm

Mirrors and handle / Lusterka i uchwyty



120 mm

Fig.	Ø	Plane / Płaskie
0	10 mm	FB.009.010
1	12 mm	FB.009.012
2	14 mm	FB.009.014
3	16 mm	FB.009.016
4	18 mm	FB.009.018
5	20 mm	FB.009.020
6	22 mm	FB.009.022
7	24 mm	FB.009.024
8	26 mm	FB.009.026
9	28 mm	FB.009.028
10	30 mm	FB.009.030



FB.010.110
110 mm





Elevators for cats and dogs / Dźwignie dla kotów i psów



Falcon - Winged

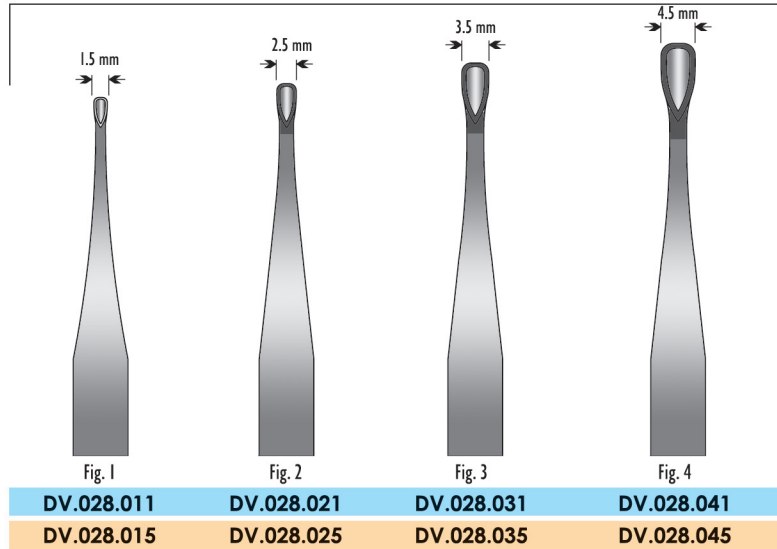

Falcon - Winged Modified

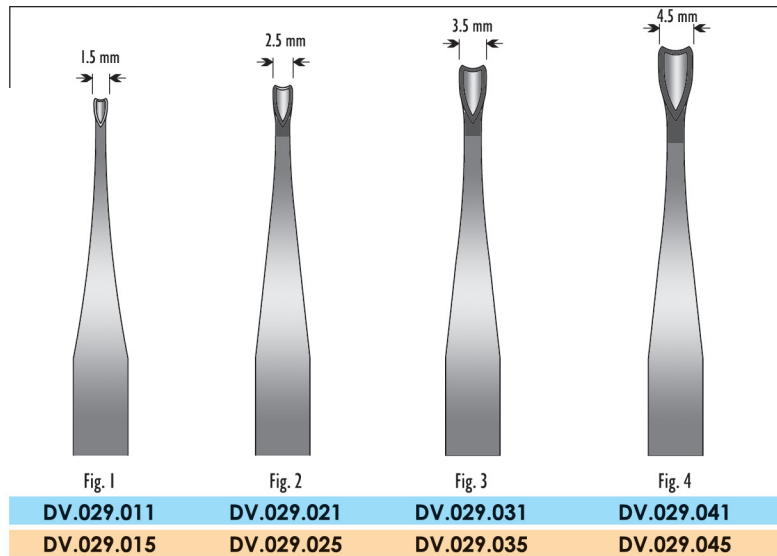

Standard Handle / Uchwyt



Slim Handle / Uchwyt

Feline

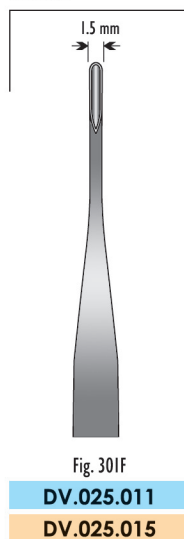

Coupland - Vet

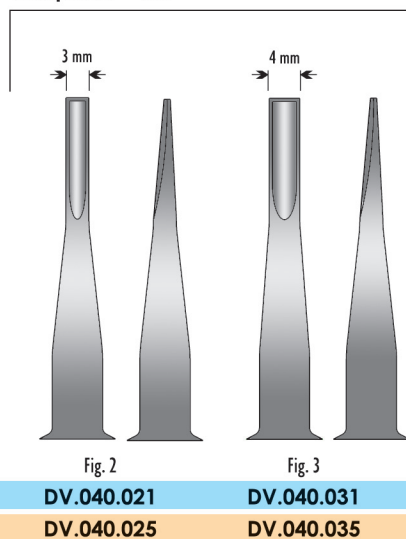



Elevators for cats and dogs / Dźwignie dla kotów i psów

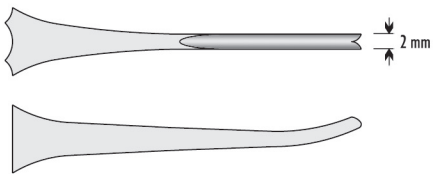

Fig. 1
DV.060.019
Lower for cats / Dolna dla kotów

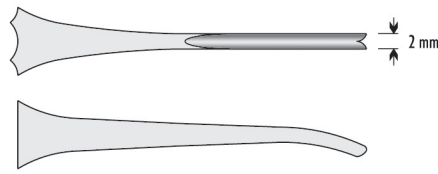

Fig. 2
DV.060.029
Upper for cats / Górna dla kotów

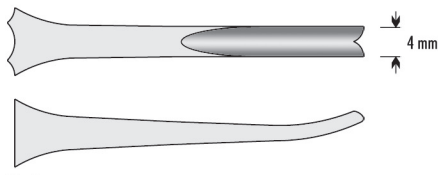

Fig. 1
DV.061.019
Lower for dogs / Dolna dla psów

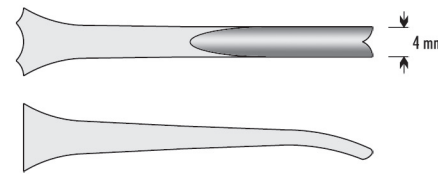

Fig. 2
DV.061.029
Upper for dogs / Górna dla psów



DV.075.010
Elevator root / Dźwignia korzeniowa



DV.080.010
Wedge Elevator / Dźwignia klinowa



2 mm **DV.090.017** 3 mm
Mini periosteal elevator / Mini elewatorium



Extraction forceps for cats / Kleszcze ekstrakcyjne dla kotów



DV.108.120



DV.110.160



DV.112.155



Extraction forceps for dogs / Kleszcze ekstrakcyjne dla psów



Fig. 15
DE.300.150
Lower molars
Do zębów trzonowych dolnych



Fig. 150
DE.301.500
Upper incisors, canines, premolars and roots
Do zębów przednich, przedtrzonowych i korzeni górnych



Fig. 151
DE.301.510
Lower incisors, canines, premolars and roots roots
Do zębów przednich, przedtrzonowych i korzeni dolnych



Fig. 101
DE.301.010
Upper and lower premolars
Do zębów przedtrzonowych górnych i dolnych



Scalers single ended / Sierpy jednostronne



Scharman

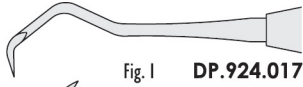

Fig. 1 DP.924.017

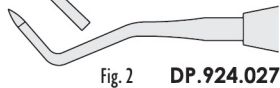

Fig. 2 DP.924.027

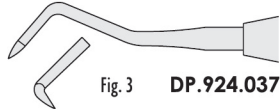

Fig. 3 DP.924.037

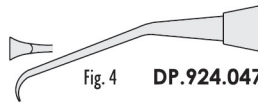

Fig. 4 DP.924.047

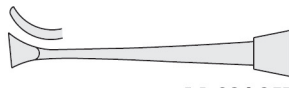

Fig. 5 DP.924.057

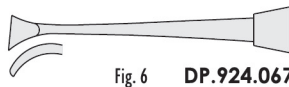

Fig. 6 DP.924.067



DP.924.000
Set of 6 pieces
Zestaw 6 szt.

Falcon



Fig. 14 DP.930.147

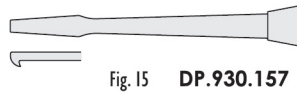

Fig. 15 DP.930.157

Scalers double ended / Sierpy dwustronne

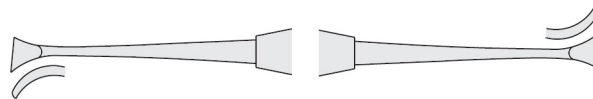

Fig. 33/34 DP.755.347 Falcon



Fig. 152 DP.774.527 Cumine

Curette double ended / Kireta dwustronna



Fig. 7/8 DP.160.089 Gracey - Vet

Tartar removal forceps
Kleszcze do usuwania kamienia nazębnego



DV.150.010 Small / Małe
DV.150.020 Large / Duże





Pluggers and spreaders / Upychadła i poszerzacze

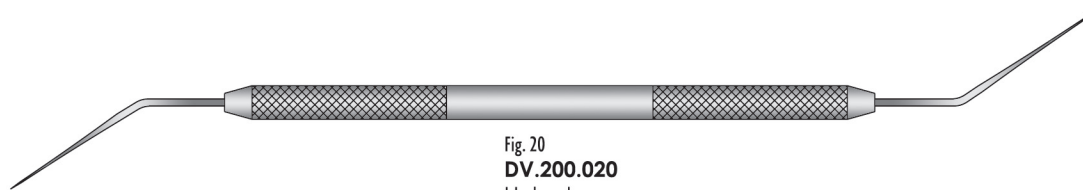
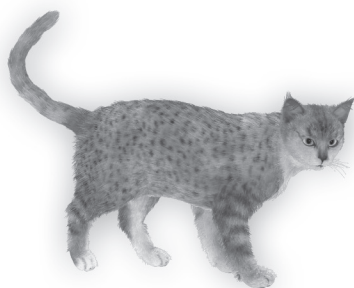

Fig. 20
DV.200.020
Holmstrom

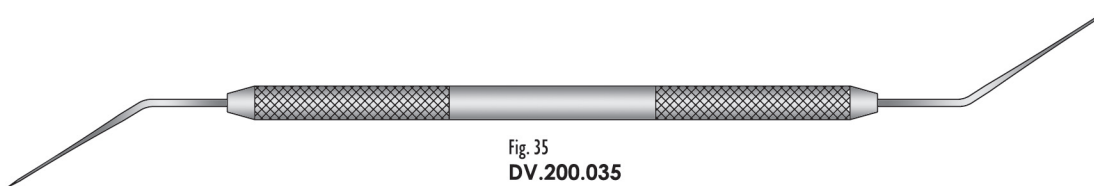

Fig. 35
DV.200.035
Holmstrom

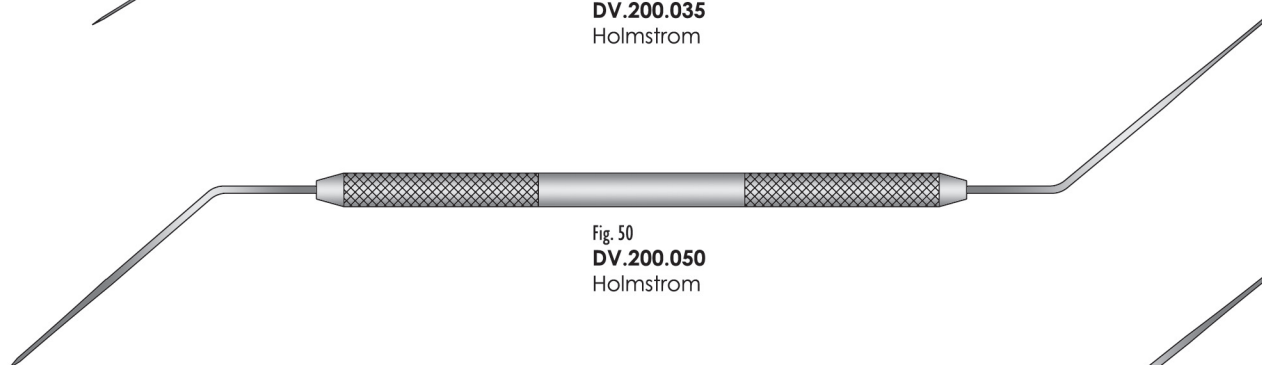

Fig. 50
DV.200.050
Holmstrom

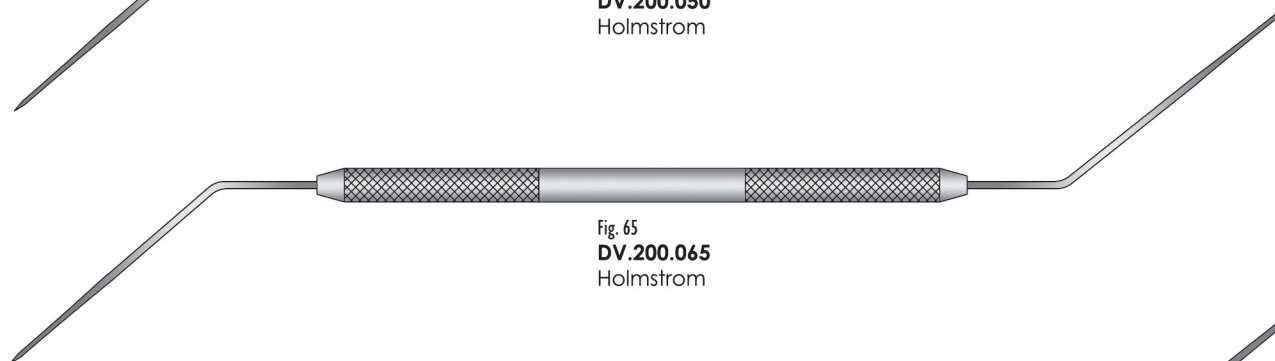

Fig. 65
DV.200.065
Holmstrom

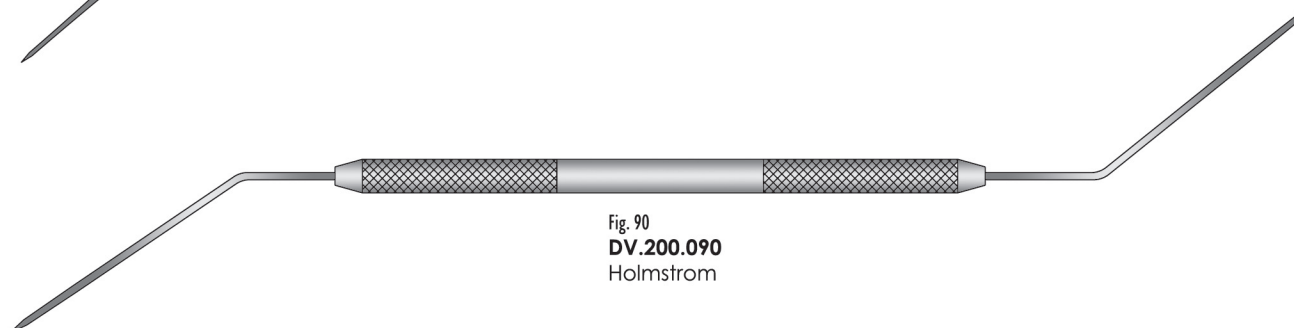
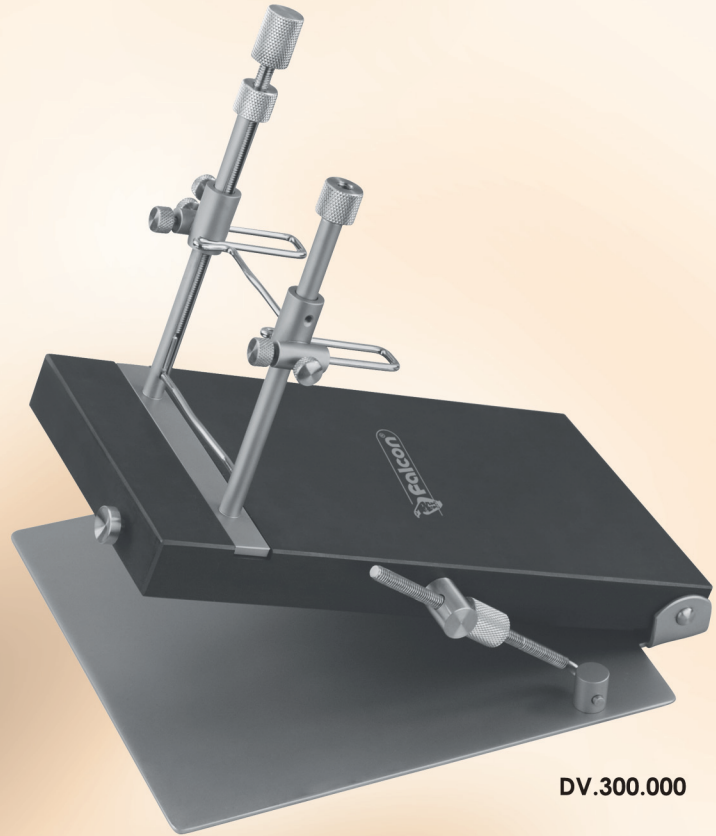

Fig. 90
DV.200.090
Holmstrom



Rodent/Rabbit dental table / Stolik stomatologiczny dla gryzoni / królików



DV.300.000

Mouth gags / Rozwieraki



Falcon
DV.310.115
115 mm

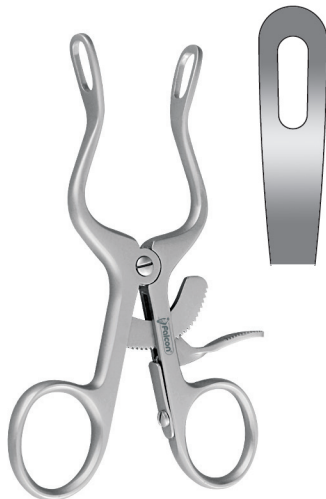

Falcon
DV.313.115
115 mm

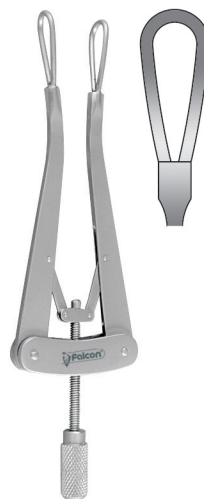

Falcon
DV.320.130
130 mm

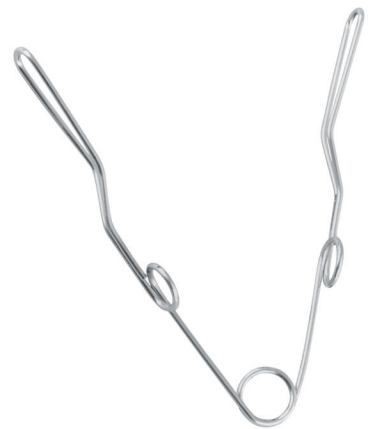

Falcon
DV.322.095
95 mm



Cheek retractors / Rozwieraki do policzków

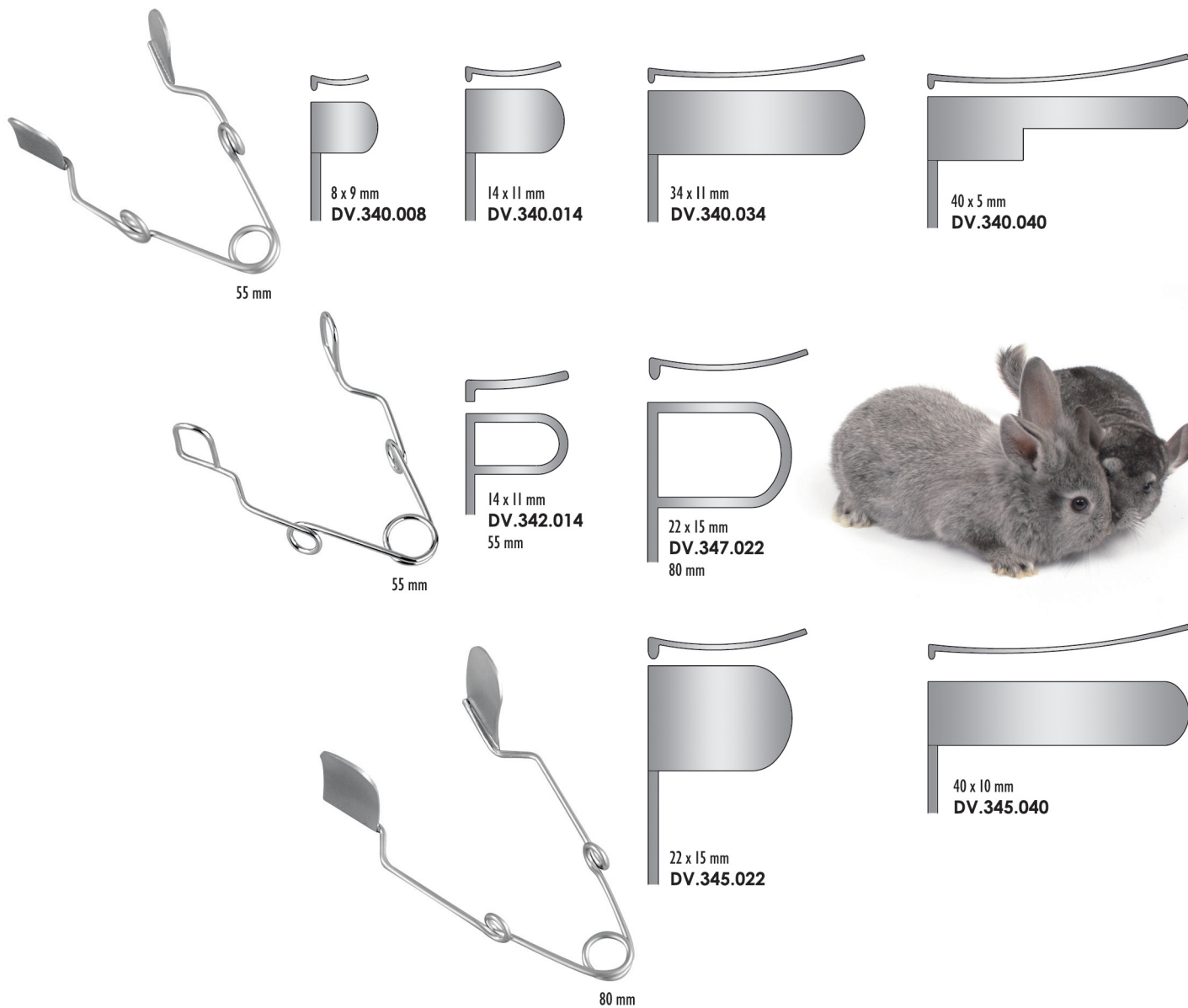

Mouth examination spatulas and tongue depressors / Szpatułki diagnostyczne i łopatki do języka

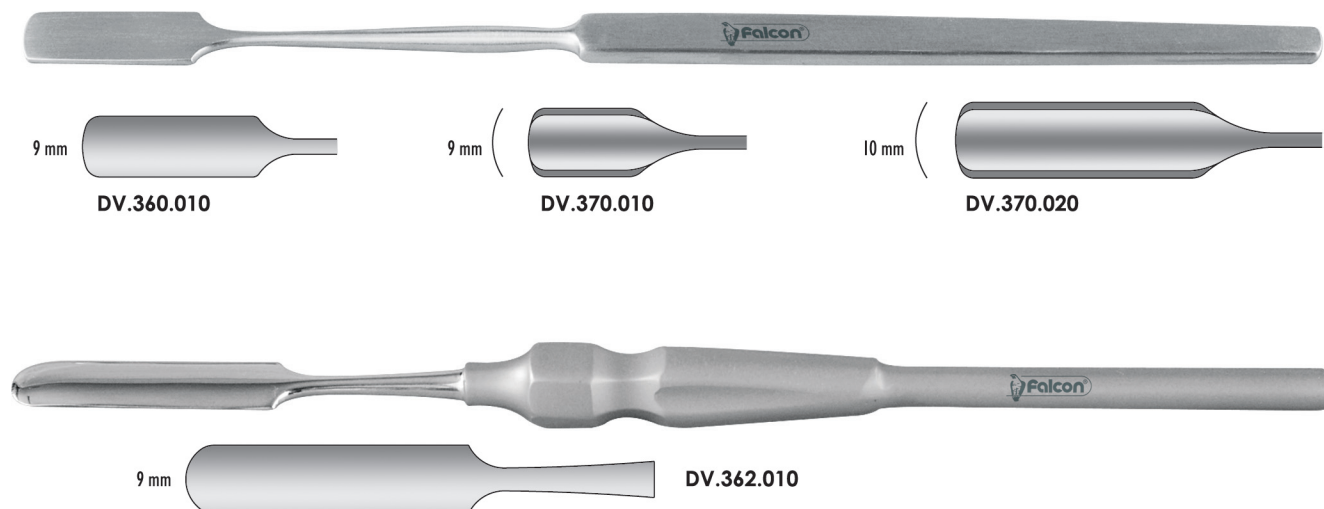



Tooth rasps / Skrobaczki do zębów

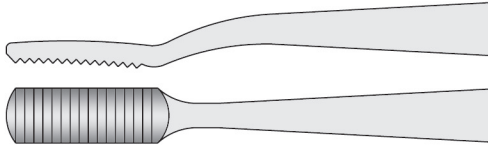

Fig. 1 DV.400.010 180 mm

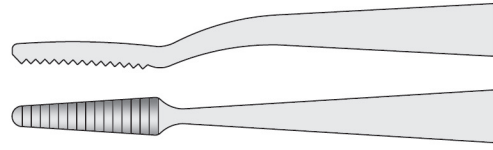

Fig. 2 DV.400.020 180 mm

Luxators / Dźwignie Luksatory



Fig. 1 DV.410.010 Incisors / Do siekaczy

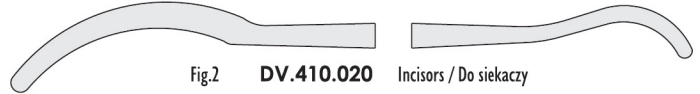

Fig. 2 DV.410.020 Incisors / Do siekaczy

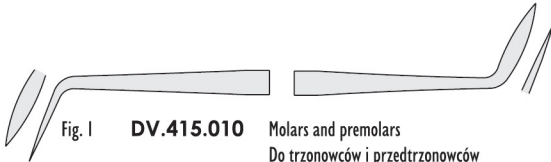

Fig. 1 DV.415.010 Molars and premolars
Do trzonowców i przedtrzonowców

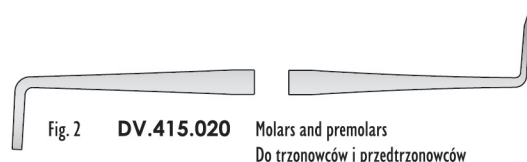
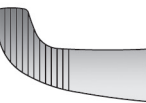

Fig. 2 DV.415.020 Molars and premolars
Do trzonowców i przedtrzonowców

Extraction forceps / Kleszcyki ekstrakcyjne



DV.430.155
155 mm
Molars and premolars
Do trzonowców i przedtrzonowców



Tooth cutter / Kleszce do przycinania zębów



DV.440.185
185 mm
Molars and premolars
Do trzonowców i przedtrzonowców

